

1A Parts in this Box / Pièces dans cette boîte:

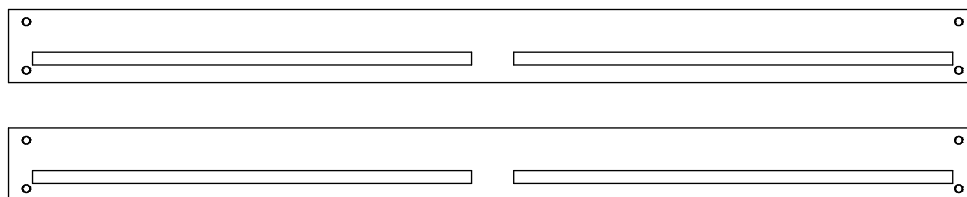

Stretchers / Rail d'étiement **x 2**

**Slats are Packed Separately in Box 4 /
Les lattes sont empaquetées séparément dans la boîte 4.**

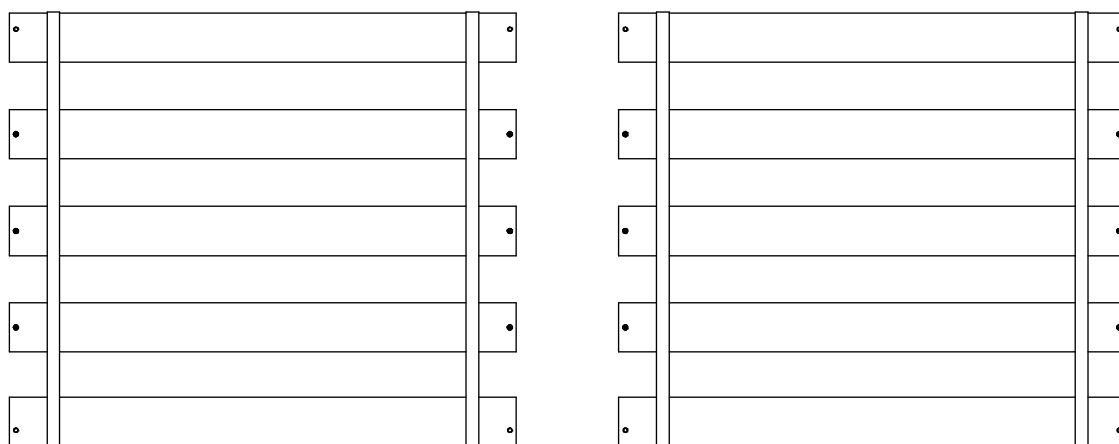

Set of Slats / Ensemble de lattes **x 2**

1B Hardware in this box / Quincaillerie incluse:

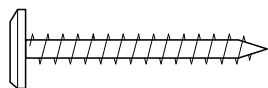

32mm Threaded Wood Bolt /
Vis à bois (32mm)
x 8



ThumNut™ /
Boulons ThumNut™ **x 8**
Patent No. / Brevet No.: US 6,457,923

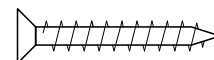

30mm Wood Screws /
Vis à bois (30mm)
x 12

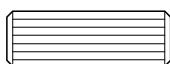

Wooden Dowels /
Goujons de bois **x 8**

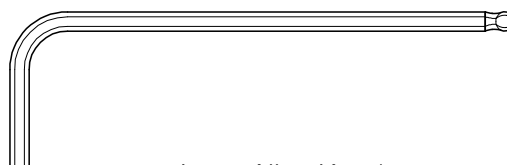

Long Allen Key /
Longue clef allen **x 1**

2A Attach the Stretchers to the Headboard and Footboard. / Attacher les rails d'étirement à la tête et au pied du lit.

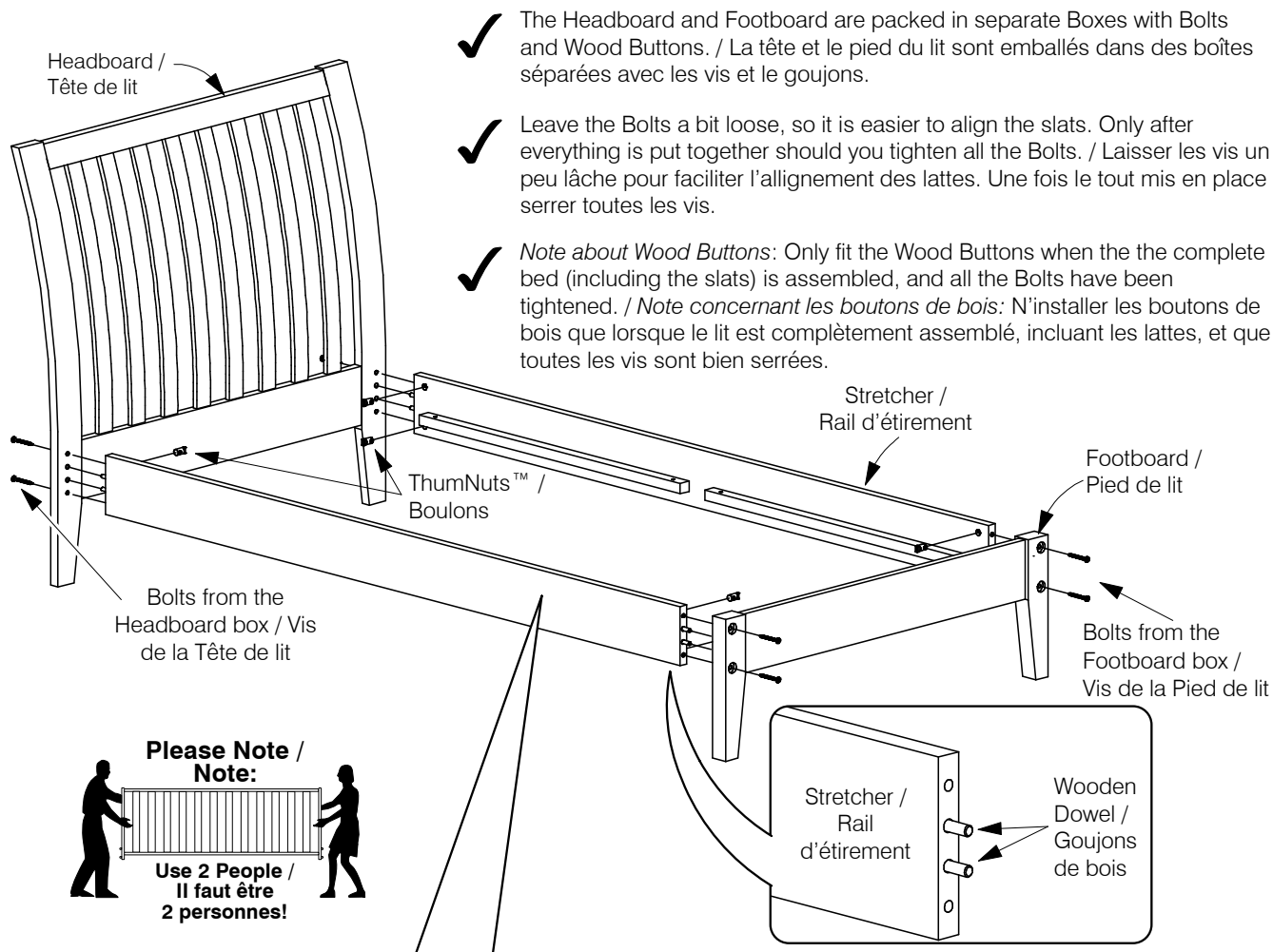

Note: The stretcher can be fitted both ways for use with, and without a Box Spring:
Le rail d'étirement peut être ajusté des deux côtés pour être utilisé avec ou sans la boîte de sommier.

With a Box Spring: /
Avec la boîte de sommier

Fit the stretcher this way... /
Adjuster le rail d'étirement
dans ce sens...

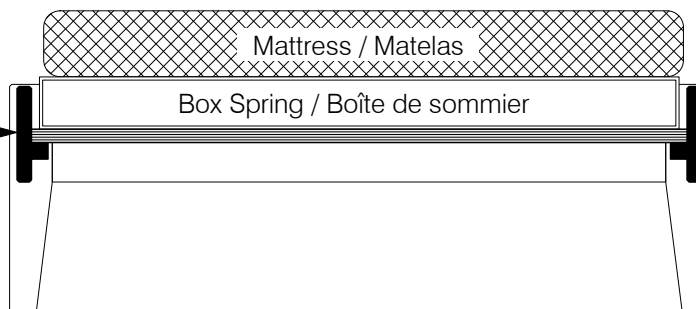

With Mattress only /
Avec matelas seulement:

Fit the stretcher this way... /
Adjuster le rail d'étirement
dans ce sens...

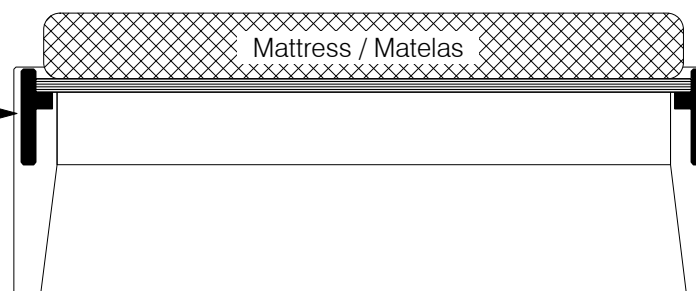

**3A Fit the other Set of Slats between the Stretchers. /
Mettre en ensemble de lattes entre les rails d'étirement.**

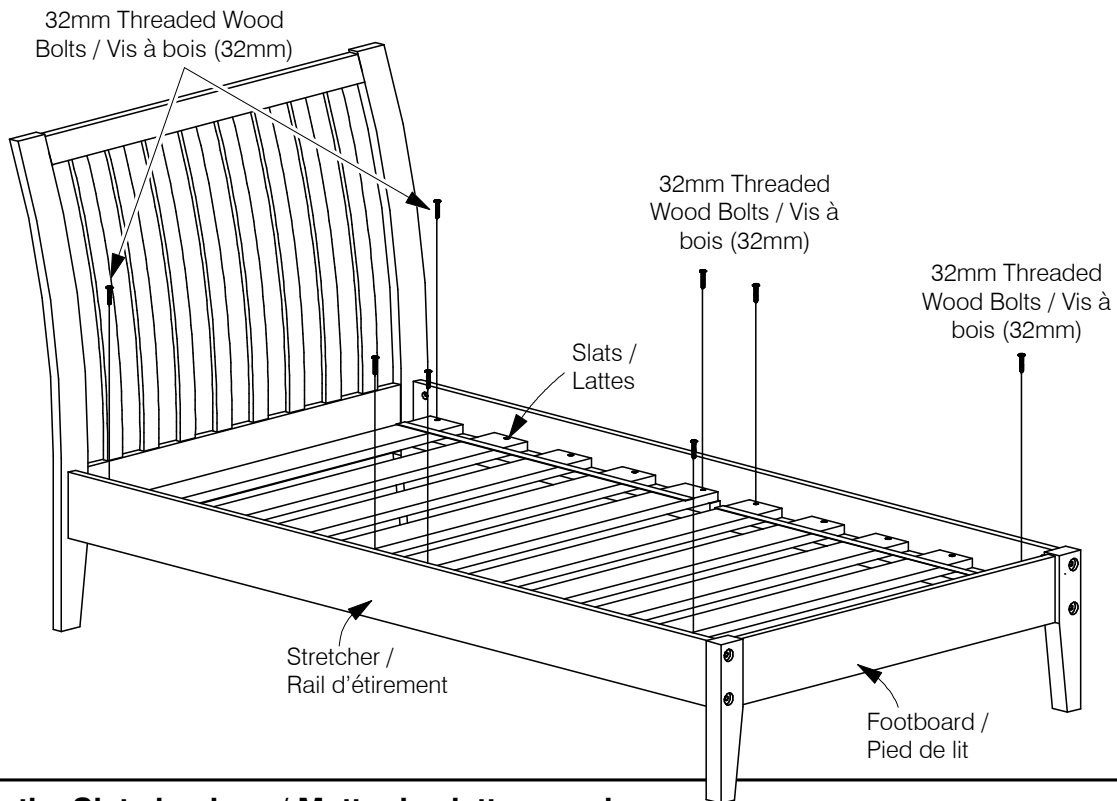

3B Fix the Slats in place / Mettre les lattes en place.

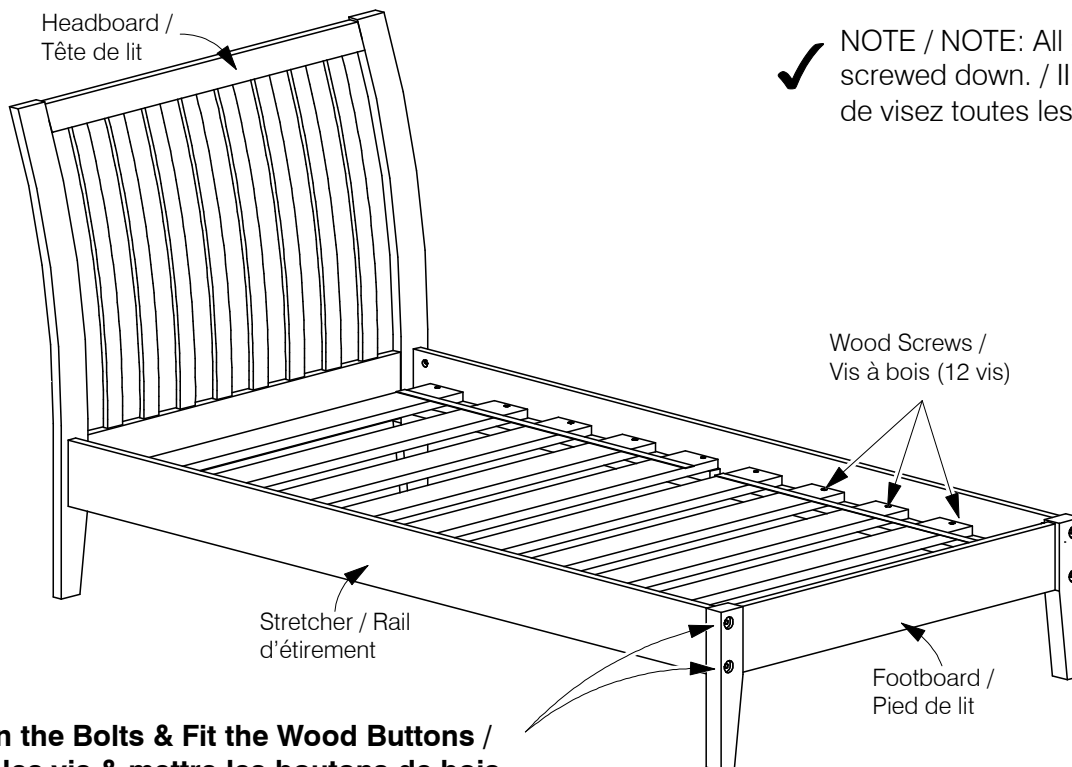

✓ **NOTE / NOTE:** All Slats must be screwed down. / Il est essential de visez toutes les lattes.

**Tighten the Bolts & Fit the Wood Buttons /
Serrer les vis & mettre les boutons de bois.**

Only when everything is put together and the Bolts have been tightened, push fit the Wood Buttons into the Bolt holes. / Seulement lorsque tout est en place et les vis serrées, mettre les boutons de bois dans les trous de vis.